

DRM-814M2

DVB-S/S2/T/T2/C HD or SD to AM scaling remodulator VSB A2

User Manual



1. Purpose of use

DRM-814M2 system is designed for a processing FTA DVB-S/S2/T/T2/C HD or SD signal into standard CCIR channels. DRM-814M2 is supplied with a A2 stereo/dual/swap dual/multistandard mono modulator, which can be used on the adjacent channels (VSB modulation) from S2 to E69. DRM-814M2 is valid for both MPEG-2 and MPEG-4 and as well H.265 signals. The multistandard modulator supports BG, I, DK, L, MN standards.

2. Installation

The connections and indications are shown in Fig 1.

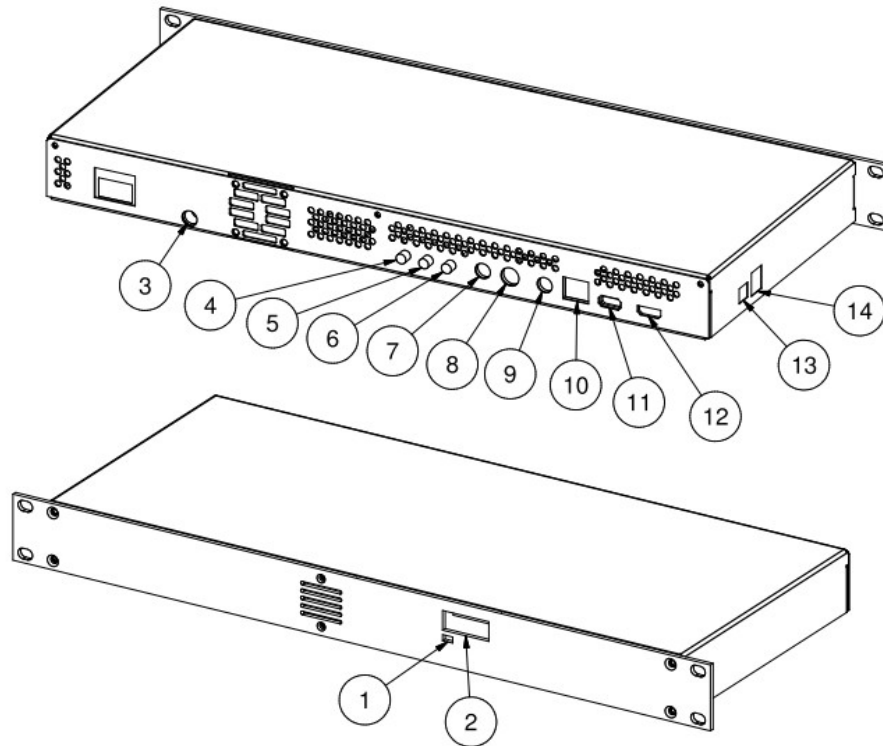

Fig 1.

1. Remote control switch: OFF (left) or ON (right). The switch must be set to OFF position when unit is powered or SW is downloaded
2. Channel number (CCIR) or TV standard. The signal led shows that the unit is powered or modulator set-up is activated
3. RF OUT
4. VIDEO OUT connector for monitoring.
5. and 6. AUDIO OUT connectors for monitoring
7. Antenna OUT
8. Antenna IN
9. LNB IN
10. ETH
11. USB port.
12. HDMI connector
13. Not used

14. RS-232 connection for SW updating

DRM-814M2 is designed for standard 19” rack mounting. Do not cover the air passage holes. Power cord is connected to power input connector 100-240VAC on the rear panel of the unit. Signal from antenna is connected to LNB or Antenna input. RF OUT is connected to cable network. VIDEO/AUDIO connectors are for monitoring the unit.

3. Programming

The receiver and modulator is simple to program with the remote control unit (RCU). The main functions of RCU are shown in Fig 2.

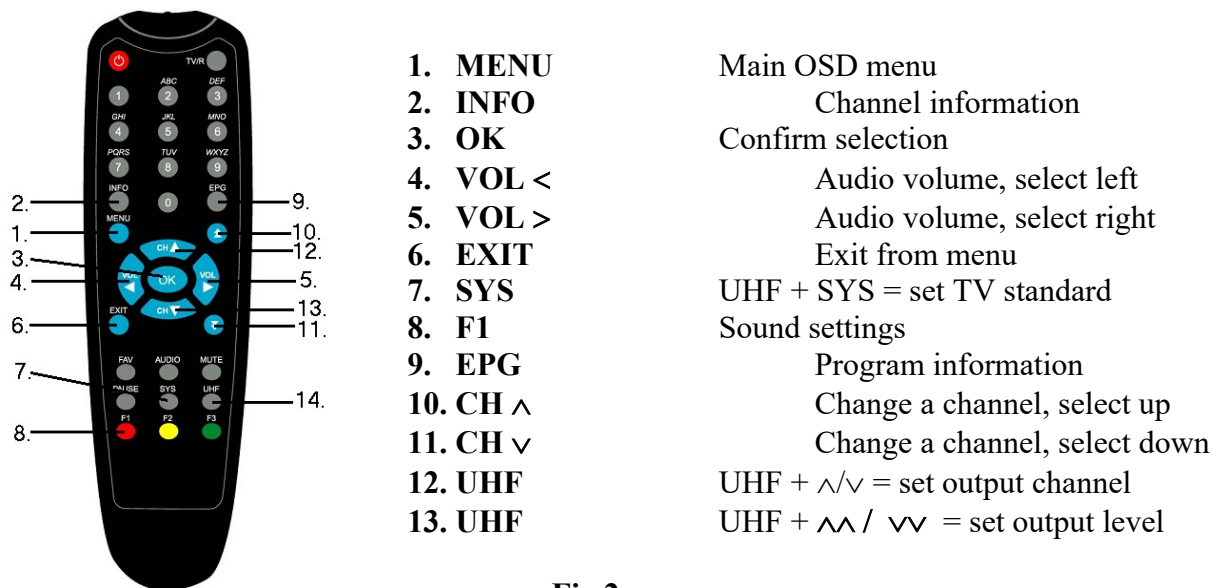

Fig 2.

NOTE! When programming is ready the switch must be set to center position.

3.1 Power-up

Before powering a unit check that the control switch is in the OFF position. After power up a black screen is displayed.

When the unit is powered the display lights up showing selected output channel. The factory set channel is E21.

The display is switched off after 3 minutes. The signal led indicate that the unit is powered. The display lights up again by pressing any button of remote controller unit.



3.2 First time set-up

When using the unit for the first time, you must first connect RCA cables to VIDEO/AUDIO connectors for monitoring the unit or set the modulator output to required channel. After this you can continue set-up using on-screen menus.

To control modulator first slide front panel switch to right position to control receiver 1 and modulator. Press UHF key on the remote. On selected output channel display a dot is lit on right lower corner. This indicates that modulator set-up is activated. Test pattern and test sound are switched on.

To change output channel press up or down CH keys to scroll through available channels. Cable TV S-channels are indicated with a dot between digits. The selectable channels are S02 - S10, 5 - 12, S11 - S41 and 21 - 69 (CCIR).

To change TV standard press SYS key repeatedly until required standard name (BG, I, DK, L or MN) is displayed.

The output level is adjusted by pressing UHF + ^^ / ^^ (double arrows).

To save modulator settings press OK key. To cancel selection, press EXIT key. Modulator set-up will be exited and test pattern and test sound will be switched off in both cases.

3.3 Set-up

To start set-up, press Menu key. Main Menu will be displayed.

Select "Settings" menu.



"Settings" menu is displayed.

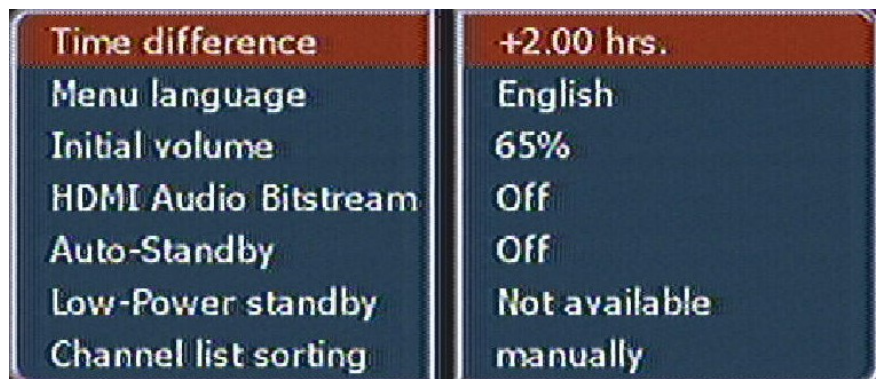
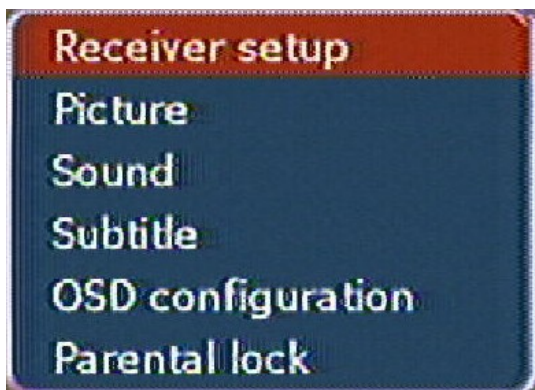

Select “Receiver setup” and select appropriate language in “Menu language”.

Do not adjust other settings of “Receiver menu”.

NOTE! If audio volume must be adjusted, you must do it in “Receiver setup”-menu. If volume is adjusted with VOL button of RCU, it is not memorized and setting will disappear after next power break.

Press “Exit” in RCU and then select “Picture” menu. Below “Picture” menu is just for your information. It is not necessary to adjust.

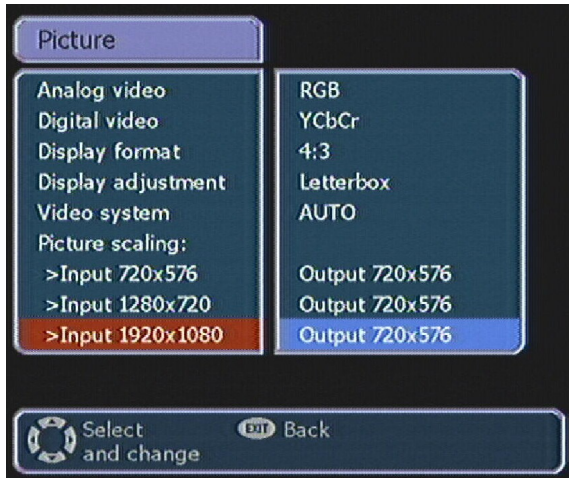

Press “Exit” in RCU and then select “Sound” menu. You need not to adjust “Sound” menu.



Sound channel is selected automatically according to source.

Press “Exit” in RCU and then select “Subtitle” menu.

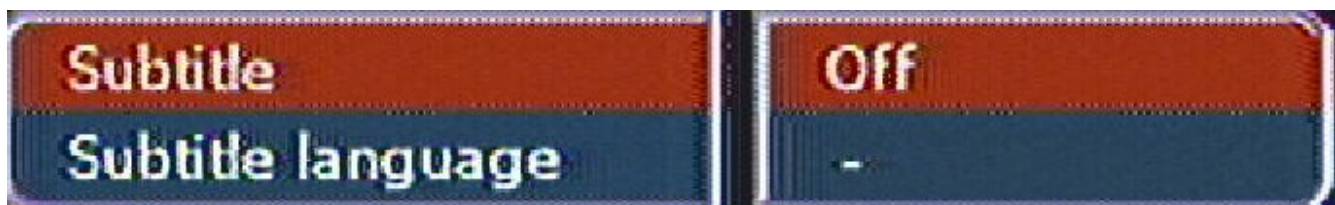

If there is subtitling in a channel, set “Subtitle” ON and select a language.

Press “Exit” in RCU twice to exit from “Settings” menu.

3.4 Channel search

Select “Installation” menu.

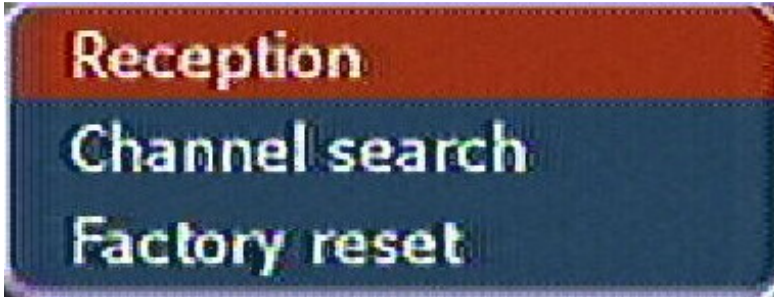

Do not adjust “Reception” menu.

Select “Channel search”.

If you must use “Factory reset”, check that “Settings” menu is according to above pictures.

Press v pushbutton of RCU to select “Search mode”.

There are two ways to search channels; “Automatic” and “Manual”.

“Manual” search is recommended as it is faster than “Automatic” mode. “Automatic” mode is used only if channel frequency is not known.

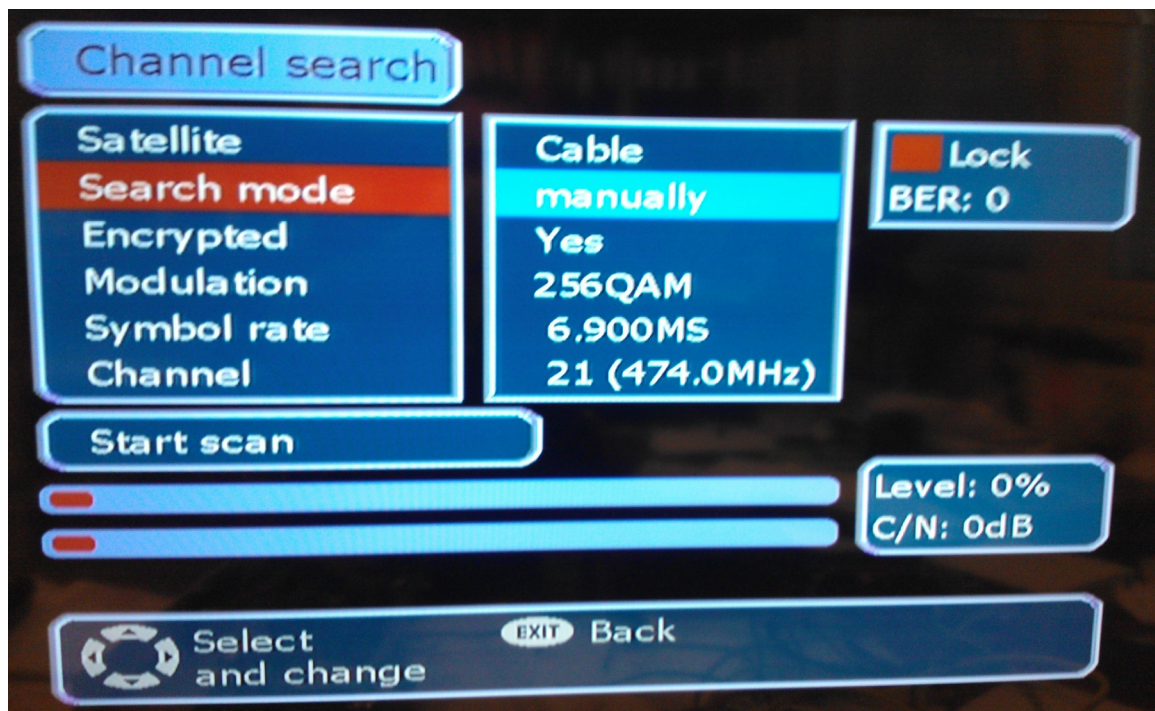

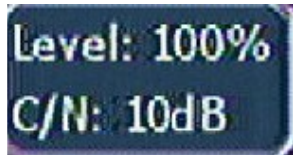
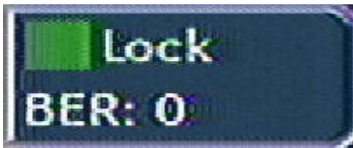

Select "Start scan" and press OK.

When scanning is ready, press "Exit" three times to exit from menu.

The program can be selected now with **CH** \wedge or **CH** \vee pushbuttons.



4. Technical specification

8PSK/QPSK/QAM/COFDM INPUT

Number of channels	1
Tuners	1
Input frequency range	47 - 2150 MHz
Input level	-70 ,, -25 dBm
Symbol rate	4 - > 45 MS/s

MODULATOR OUTPUT

Output frequency range	112,25 MHz - 855,25 MHz
Modulation	AM, VSB, A2 stereo
Transmission standard	B/G, D/K, I, L, M/N
Output level	max. 105 dBuV
Data interface	1* USB
Input connectors	F-female 75 ohm
Output connectors	F-female 75 ohm
Power	100 – 240 VAC, 50-60Hz
Dimensions	19”, 1RU



This symbol on the product or on its packing means that within the European Union the product must be taken to separate collection at the product-end-of life.

Do not dispose of these products as unsorted municipal waste.

Fore more information about where you can drop off your waste equipment for recycling, please contact your local city office, your house disposal service or the shop where you purchased the product.

